



INVIXIUM

INGUIDE

Quick Start Guide



In the Box



Dolphin Crimps
(qty 12)



Earth Ground Wire



Wall Mounting Screws
(qty 4)



Metal Mounting
Plate Screw
(qty 1)



Hex Key



Metal Mounting
Plate

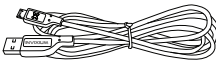

Micro USB Extension
Cable (4 ft/1.2m)



Snubber Diode



Ferrite Core
(Selected variants only)



Wired Back Cover



USB Cover Screw
(qty 1)



Gangue Box
Mounting Screws
(qty 2)

SENSE 2 & TOUCH 2 Only

IXM INSTALL KIT

Getting Started

- 1 Remove the Mounting Plate, Wired Back Cover and Screws from the IXM INSTALL KIT.
- 2 Install the Mounting Plate at the desired location (INVIXIUM recommends 135-140 cm from the floor to the top of the device).
- 3 Make the necessary connections to the Wired Back Cover (refer to [Get Wired Pages](#)).
- 4 Unscrew and remove the Temporary Back Cover from the IXM device and connect the Wired Back Cover using the same screws.
- 5 Hang your IXM device on the Mounting Plate and secure it on the bottom with the screw provided.



Get Wired Glossary

ACP	Access Control Panel	RLY	Relay
COM	Common	RX	Receiver
DAC	Door Access Control	SGND	Signal Ground
DSP	Door Strike Power	SPI	Specific Purpose Input
EGND	Earth Ground	SPO	Specific Purpose Output
GND	Ground	TX	Transmitter
LED	Light Emitting Diode	WDATA	Wiegand Data
NC	Normally Closed	WGND	Wiegand Ground
NO	Normally Open	VIN+	Power (12VDC)
PoE	Power over Ethernet	VIN-	Power Ground



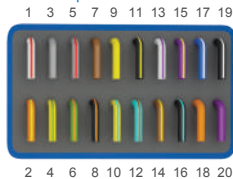



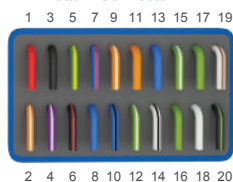













Top Connector

















Bottom Connector



Get Wired Top Connector

Wire Color	Wire	Label	Pin(s)	Wire Color	Wire	Label	Pin(s)
White/Red		RLY_NC	1	Orange/Yellow		SPO_1	2
Grey		RLY_COM	3	Yellow/Green		SPO_2	4
Grey/Red		RLY_NO	5	Green/Orange		SPO_3	6
Brown		ACP_LED1	7	Black/Orange		SPO_GND	8
Yellow		ACP_LED2	9	Yellow/Cyan		SPI_1	10
Black/Yellow		ACP_LED_GND	11	Cyan/Brown		SPI_2	12
White/Purple		DAC_IN1	13	Brown/Yellow		SPI_3	14
Purple/Yellow		DAC_IN2	15	Black/Cyan		SPI_GND	16
Blue/White		DAC_IN3	17	Orange		DAC_OUT	18
Black/White		DAC_GND	19	Purple		DAC_DSP	20

Get Wired Bottom Connector

Wire Color	Wire	Label	Pin(s)	Wire Color	Wire	Label	Pin(s)
Red		VIN+	1	Orange/White		RS232_RX	2
Black		VIN-	3	Purple/White		RS232_TX	4
Green/Yellow		EGND	5	Black/Red		SGND	6
RJ45 Receptacle		TCP/IP	9,11,13, 15,17,19	Blue		RS485+ (B)	8
				Blue/Black		RS485- (A)	10
				Green/White		WDATA_IN0	12
				White/Black		WDATA_IN1	14
				Green		WDATA_OUT0	16
				White		WDATA_OUT1	18
				Black/Green		WGND	20

Earth Ground

For protection against Electrostatic Discharge, Invixium recommends the use of a ground connection between each IXM device to a high quality Earth Ground available at the install site.

Connect to Earth Ground in one of two ways:

1 EGND wire (Green/Yellow) from the Wired Back Plate

or

2 Loose Earth Ground wire direct to the mounting plate using one of the wall mounting screws (as shown). Ensure that the lug is secured tightly for contact between the device and the mounting plate.

Ensure all Earth Ground connections are made to each device prior to turning on the power.



Power It Up

When using an external power supply, ensure that the regulated, filtered and dedicated power source (Safety tested, FCC/IC/CE certified) provides a minimum of 1A @ 12 VDC for MYCRO, SENSE 2 and TOUCH 2.

When using PoE for demo purposes, an IEEE 802.3af compliant Active Midspan Injector is required (sold separately). Refer to table for INVIXIUM recommended PoE Injector specs. Full PoE deployments should include a centralized PoE PSE. Both IEEE 802.3af power transmission modes (A and B) are supported.

PoE+ connectivity is available on all SENSE 2 and TOUCH 2 models.

INVIXIUM recommends the use of battery back up or a UPS with built-in surge protection.

WARNING: Product Warranty is void if improper power (under or over) is supplied to the device.



INVIXIUM recommended PoE Injector Specs

Input Voltage	90-264 VAC, 60 Hz
Input Current	0.4 A @ 100 VAC
Output Voltage	48 VDC
Output Current	0.32 A
Power	15.36 Watt

Ethernet and Wi-Fi

For Ethernet communication, a specific range of allowable IP addresses can be set for improved security.

For Wi-Fi communication on the TOUCH 2 (select models), 802.11 b/g/n protocols are supported. DHCP is enabled as a factory default. WEP, WPA and WPA2 encryption options are available.

NOTE: PoE connectivity is not available on the MYCRO.



RS-485 Configuration

For RS-485 networks, ensure that IXM devices are wired in a daisy chain configuration, up to a maximum of 31 devices. At a baud rate of 9600 bps, make certain that the maximum cable length is not longer than 1200 m (4000 ft).



R = 120 ohms for Standard RS-485 Cabling
R = 100 ohms for CAT5/6 Cabling

Bottom Connector RS-485

SGND	(6)	
RS-485+	(8)	
RS-485-	(10)	

Serial Communication and USB

For Serial Communication, IXM devices are equipped with RS-232 and USB capabilities.

Refer to [Get Wired Bottom Connector](#) page for RS-232 connections.

The USB port can be used to connect a Flash Drive via Micro USB OTG cable and perform functions like upgrading firmware, downloading transaction logs and configuration files.

The USB port can also be used to connect to a PC running IXM WEB via Micro USB cable.



Micro USB Cable



Micro USB OTG Cable



Bottom USB Port

Wiegand

IXM devices have the option to use the Standard 26-bit Wiegand format or a Custom Wiegand format (up to 512 bits) to suit any Access Control System.

All IXM devices are set to Standard 26-bit format as a factory default.

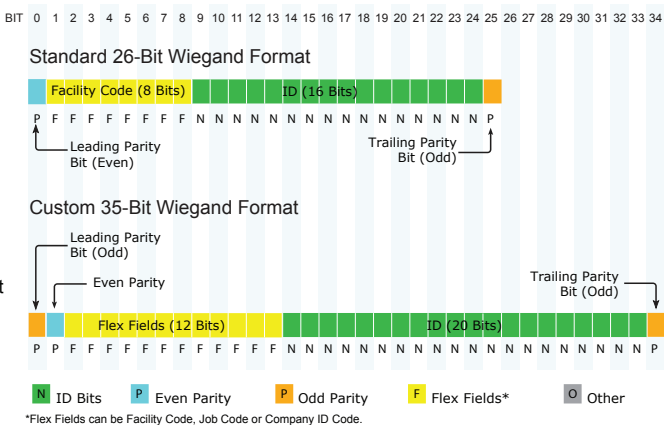

ACP Connections



Top Connector LED

ACP_LED1		(7)
ACP_LED2		(9)
ACP_LED_GND		(11)

Bottom Connector Wiegand

WDATA_OUT0		(16)
WDATA_OUT1		(18)
WGND		(20)

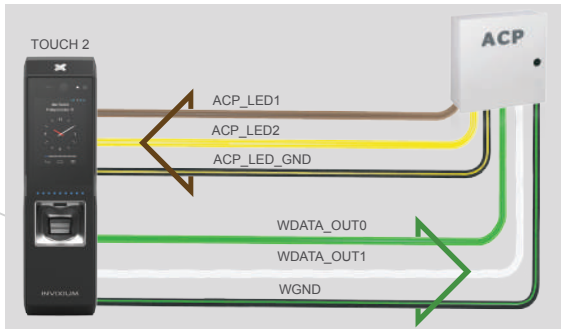

ACP_LED signals can be used if available on the Access Control Panel. IXM devices support up to 2 wires + GND for LED status.

DAC Connections (Electric Door Strike)

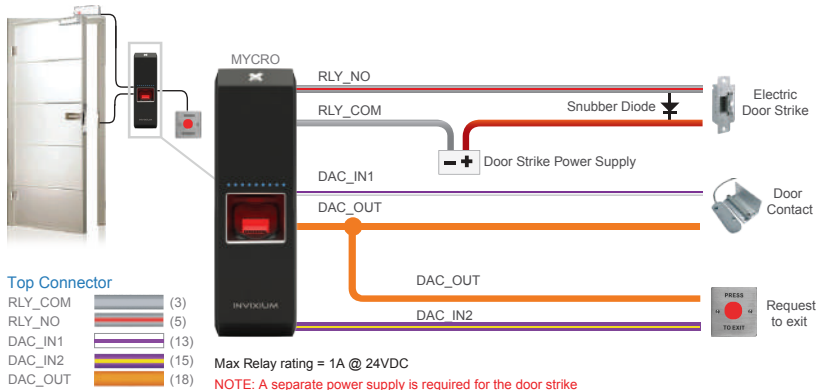

DAC Connections (Magnetic Lock)

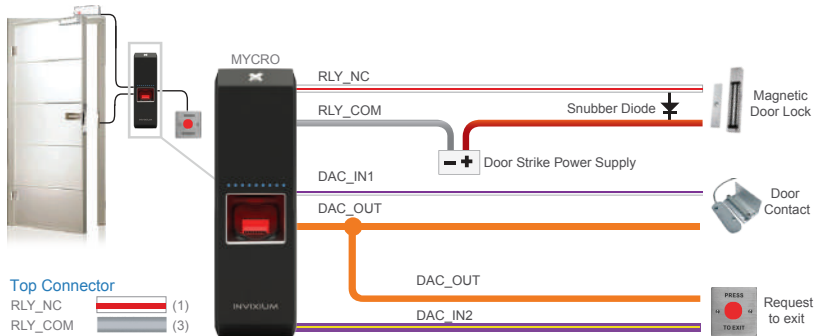

Top Connector

RLY_NC	(1)
RLY_COM	(3)
DAC_IN1	(13)
DAC_IN2	(15)
DAC_OUT	(18)

Max Relay rating = 1A @ 24VDC

NOTE: A separate power supply is required for the door strike



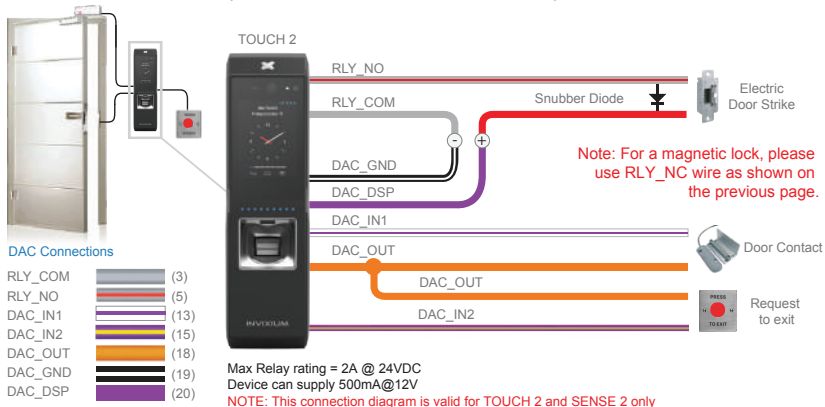



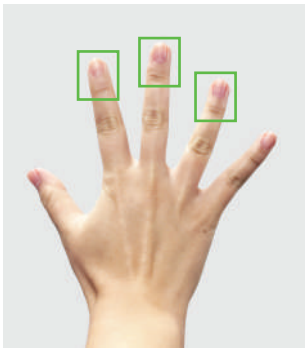







DAC Connections (Device Powers Door Strike)



Enrollment Best Practices



Preferred Fingers

	 Incorrect	 Correct	
Pressure	 Too Low	 Too High	 Good
Position			
Rotation			
Condition	 Dry	 Wet	 Good

INGUIDE

This is a Quick Start Guide. For a detailed guide please refer the Invixium Installation Guide.

Visit the Customer Portal for more Invixium resources at www.support.invixium.com.

For technical or customer support issues, please contact your Local Authorized Reseller first.



INVIXIUM

Contact Invixium Support at support@invixium.com.

Enjoy the Experience.

Some features may vary based on device models. Copyright © 2019, INVIXIUM. All rights reserved.

INVIXIUM.COM

© 2019 Google Inc. All rights reserved. Chrome™ browser is a trademark of Google Inc.
Firefox logo® is a registered trademark of the Mozilla Foundation.
Windows®, Internet Explorer® and Edge® are trademarks of the Microsoft group of companies.
Safari® is a trademark of Apple Inc.

P/N XAD-00E-115-03G