



SENSE 2



TOUCH 2



MYCRO

# INGUIDE

## Quick Start Guide

# Inxium Customer Portal

Stay up to date with:

- Latest Updates
- Best Practices
- Datasheets
- Installation Guides
- Feature Description Documents
- Videos
- FAQs
- Tutorials
- And more...

Visit <https://www.inxium.com/support/>

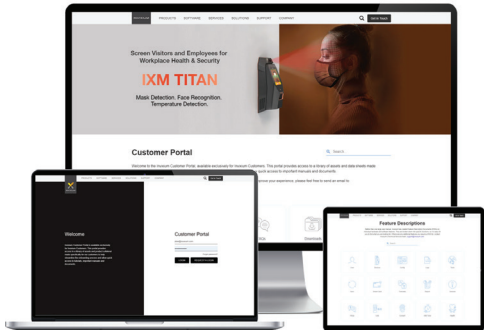

# In the Box



Dolphin Crimps  
(qty 12)



Earth Ground Wire



Wall Mounting Screws  
(qty 4)



Metal Mounting  
Plate Screw  
(qty 1)



Hex Key



Metal Mounting  
Plate

## IXM INSTALL KIT



Snubber Diode

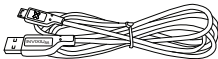

Micro USB Extension  
Cable (4 ft/1.2m)



Ferrite Core  
(Selected variants only)

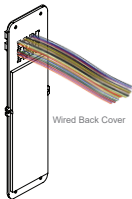

Wired Back Cover



USB Cover Screw  
(qty 1)



Gangue Box  
Mounting Screws  
(qty 2)

SENSE 2 & TOUCH 2 Only

## Getting Started

- 1 Remove the Mounting Plate, Wired Back Cover and Screws from the IXM INSTALL KIT.
- 2 Install the Mounting Plate at the desired location. Invixium recommends 120 cms from the floor to the bottom of the device.
- 3 Make the necessary connections to the Wired Back Cover (refer to [Get Wired Pages](#)).
- 4 Unscrew and remove the Temporary Back Cover from the device and connect the Wired Back Cover using the same screws.
- 5 Hang your device on the Mounting Plate and secure it on the bottom with the screw provided.



## Get Wired Glossary

<b>ACP</b>	Access Control Panel	<b>RLY</b>	Relay
<b>COM</b>	Common	<b>RX</b>	Receiver
<b>DAC</b>	Door Access Control	<b>SGND</b>	Signal Ground
<b>DSP</b>	Door Strike Power	<b>SPI</b>	Specific Purpose Input
<b>EGND</b>	Earth Ground	<b>SPO</b>	Specific Purpose Output
<b>GND</b>	Ground	<b>TX</b>	Transmitter
<b>LED</b>	Light Emitting Diode	<b>WDATA</b>	Wiegand Data
<b>NC</b>	Normally Closed	<b>WGND</b>	Wiegand Ground
<b>NO</b>	Normally Open	<b>VIN+</b>	Power (12VDC)
<b>PoE</b>	Power over Ethernet	<b>VIN-</b>	Power Ground



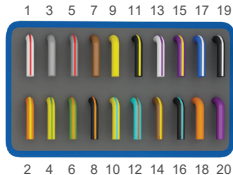



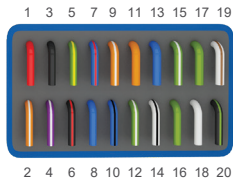













### Top Connector

















### Bottom Connector



## Get Wired Top Connector

Wire Color	Wire	Label	Pin(s)	Wire Color	Wire	Label	Pin(s)
White/Red		RLY_NC	1	Orange/Yellow		SPO_1	2
Grey		RLY_COM	3	Yellow/Green		SPO_2	4
Grey/Red		RLY_NO	5	Green/Orange		SPO_3	6
Brown		ACP_LED1	7	Black/Orange		SPO_GND	8
Yellow		ACP_LED2	9	Yellow/Cyan		SPI_1	10
Black/Yellow		ACP_LED_GND	11	Cyan/Brown		SPI_2	12
White/Purple		DAC_IN1	13	Brown/Yellow		SPI_3	14
Purple/Yellow		DAC_IN2	15	Black/Cyan		SPI_GND	16
Blue/White		DAC_IN3	17	Orange		DAC_OUT	18
Black/White		DAC_GND	19	Purple		DAC_DSP	20

## Get Wired Bottom Connector

Wire Color	Wire	Label	Pin(s)	Wire Color	Wire	Label	Pin(s)
Red		VIN+	1	Orange/White		RS232_RX	2
Black		VIN-	3	Purple/White		RS232_TX	4
Green/Yellow		EGND	5	Black/Red		SGND	6
RJ45 Receptacle		TCP/IP	9,11,13, 15,17,19	Blue		RS485+ (B)	8
				Blue/Black		RS485- (A)	10
				Green/White		WDATA_IN0	12
				White/Black		WDATA_IN1	14
				Green		WDATA_OUT0	16
				White		WDATA_OUT1	18
				Black/Green		WGND	20

## Earth Ground

For protection against Electrostatic Discharge, Invixium recommends the use of a ground connection between each IXM device to a high quality Earth Ground available at the install site.

Connect to Earth Ground in the following way:

- 1 Connect the green and yellow earthing wire from the wired back cover (bottom connector PIN 5) to the building earthing.
- 2 Connect the open end of earth ground wire provided in the Install Kit Box to the building earthing as well.
- 3 Screw the lug end of the earth ground wire to the metal mounting plate.
- 4 Ensure all Earth Ground connections are made to each device prior to turning on the power.

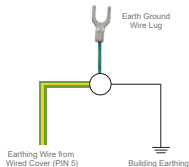

Earth Ground Connections



## Power It Up

When using an external power supply, ensure that the regulated, filtered and dedicated power source (Safety tested, FCC/IC/CE certified) provides a minimum of 1.5A @ 12 VDC.

When using PoE, an IEEE 802.3af compliant Active Midspan Injector is required (sold separately). Refer to table for Invixium recommended PoE Injector specs. Full PoE deployments should include a centralized PoE PSE. Both IEEE 802.3af power transmission modes (A and B) are supported. Invixium recommends the use of battery back up or a UPS with built-in surge protection.

**Note:** MYCRO models do not support PoE.

SENSE 2 and TOUCH 2 models support PoE as well as PoE+.

**WARNING:** Product Warranty is void if improper power (under or over) is supplied to the device.



### INVIXIUM recommended PoE Injector Specs

<b>Input Voltage</b>	90-264 VAC, 60 Hz
<b>Input Current</b>	0.4 A @ 100 VAC
<b>Output Voltage</b>	48 VDC
<b>Output Current</b>	0.32 A
<b>Power</b>	15.36 Watt

## Ethernet and Wi-Fi

For Ethernet communication, a specific range of allowable IP addresses can be set for improved security.

For Wi-Fi communication on TOUCH 2 (selected models only), 802.11 b/g/n protocols are supported. DHCP is enabled as a factory default. WEP, WPA and WPA2 encryption options are available.



## RS-485 Configuration

For RS-485 networks, ensure that IXM devices are wired in a daisy chain configuration, up to a maximum of 31 devices. At a baud rate of 9600 bps, make certain that the maximum cable length is not longer than 1200 m (4000 ft).

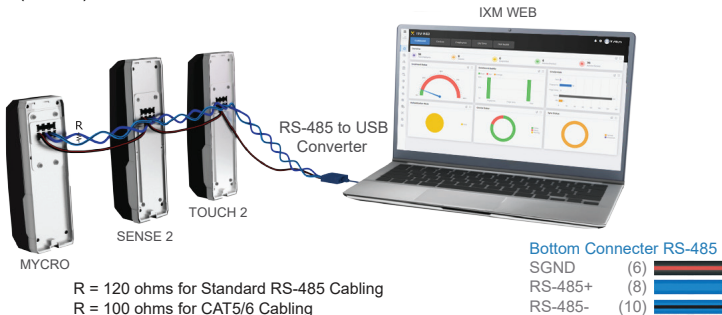

## Serial Communication and USB

For Serial Communication, IXM devices are equipped with RS-232 and USB capabilities.

Refer to [Get Wired Bottom Connector](#) page for RS-232 connections.

The USB port can be used to connect a Flash Drive via Micro USB OTG cable and perform functions like upgrading firmware, downloading transaction logs and configuration files.

The USB port can also be used to connect to a PC running IXM WEB via Micro USB cable.



Micro USB Cable



Micro USB OTG Cable  
(sold separately)



Bottom USB Port

# Wiegand

IXM devices have the option to use the standard 26-bit Wiegand format or a custom Wiegand format (up to 512 bits) to suit any Access Control System.

All IXM devices are set to Standard 26-bit format as a factory default.

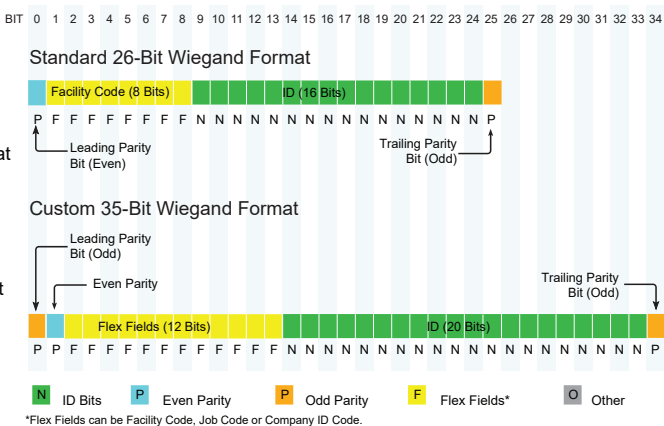

# ACP Connections



## Top Connector LED

ACP_LED1		(7)
ACP_LED2		(9)
ACP_LED_GND		(11)

## Bottom Connector Wiegand

WDATA_OUT0		(16)
WDATA_OUT1		(18)
WGND		(20)

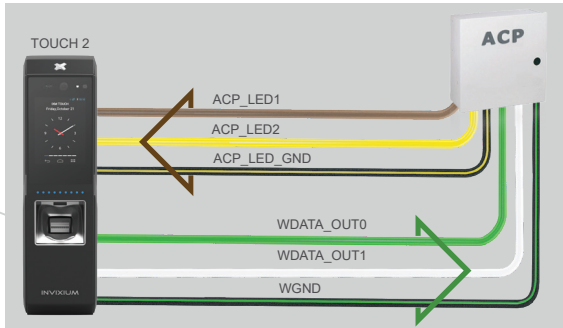





ACP\_LED signals can be used if available on the Access Control Panel. IXM devices support up to 2 wires + GND for LED status.

# DAC Connections (Electric Door Strike)



## Top Connector

RLY_COM		(3)
RLY_NO		(5)
DAC_IN1		(13)
DAC_IN2		(15)
DAC_OUT		(18)

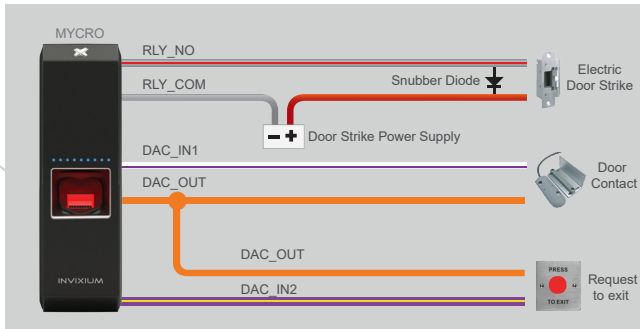



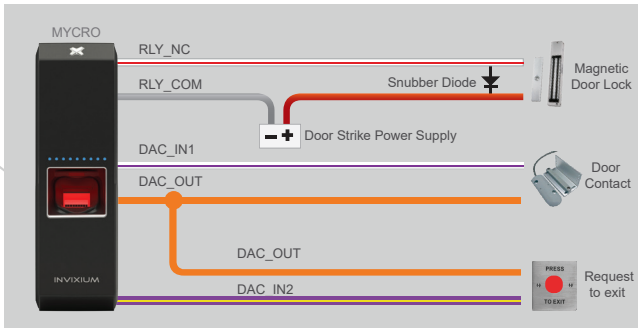

Max Relay rating = 2A @ 24VDC

**NOTE:** A separate power supply is required for the door strike

# DAC Connections (Magnetic Lock)



## Top Connector

RLY_NC		(1)
RLY_COM		(3)
DAC_IN1		(13)
DAC_IN2		(15)
DAC_OUT		(18)

Max Relay rating = 2A @ 24VDC





**NOTE:** A separate power supply is required for the door strike



# DAC Connections (Device Powers Door Strike)



## DAC Connections

RLY_COM		(3)
RLY_NO		(5)
DAC_IN1		(13)
DAC_IN2		(15)
DAC_OUT		(18)
DAC_GND		(19)
DAC_DSP		(20)

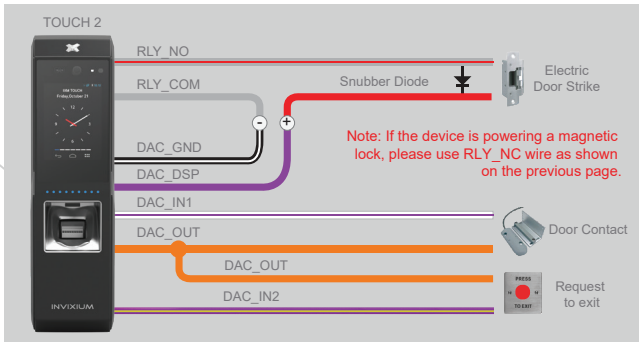

Max Relay rating = 2A @ 24VDC







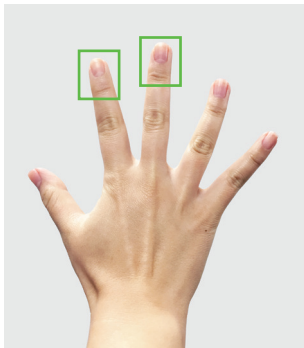







Device can supply 500mA@12V

**NOTE:** This connection diagram is valid for TOUCH 2 and SENSE 2 only

# Enrollment Best Practices



Preferred Fingers

	 Incorrect	 Correct	
Pressure	 Too Low	 Too High	 Good
Position	 Too Low	 Too High	 Good
Rotation	 Too Low	 Too High	 Good
Condition	 Dry	 Wet	 Good

## Finger Placement Best Practices

1. Proper finger placement is crucial for good enrollment score and faster authentication.
2. Place your finger straight on the sensor as shown below, while covering the sensor with the top third of your finger as shown on the previous page.



## Card Placement

1. The location of the card reader on Invixium devices depends on the product model.
2. For MYCRO and SENSE 2, the card reader is located above the sensor cavity, while for TOUCH 2 the card reader is located below the sensor cavity.
3. See below for the correct card placement while using the MYCRO, SENSE 2 and TOUCH 2.



MYCRO



SENSE 2



TOUCH 2

# Software Installation

- 1 Go to [www.invixium.com](http://www.invixium.com) >> [IXM WEB](#) >> [Get IXM WEB](#).
- 2 Follow the instructions on the screen. Enter your details and click [submit](#). You will then be sent an email with the latest IXM WEB package.
- 3 [Extract](#) the compressed file and [run](#) IXM WEB.exe. Invixium recommends selecting [Install](#) for easier installation.
- 4 When installation is complete, click [Exit](#). The IXM WEB icon will now be on your desktop.
- 5 Use the [IXM WEB icon](#) to run IXM WEB in your default web browser.
- 6 Contact [support@invixium.com](mailto:support@invixium.com) in case of any issues.



# INGUIDE

This is a Quick Start Guide. For a detailed guide please refer the Invixium Installation Guide.

For technical or customer support issues, please contact your Local Authorized Reseller first.

Visit the Customer Portal for more Invixium resources at [www.invixium.com/support](http://www.invixium.com/support)



Enjoy the Experience.

Some features may vary based on device models.  
Copyright © 2021, INVIXIUM. All rights reserved.

[invixium.com](http://invixium.com)

Contact Invixium Support at:

✉ [support@invixium.com](mailto:support@invixium.com)

☎ +1 844 INVIXIUM (468 4948)

📱 [invixium\\_support](#)

© 2019 Google Inc. All rights reserved. Chrome™ browser is a trademark of Google Inc.  
Firefox logo® is a registered trademark of the Mozilla Foundation.  
Windows®, Internet Explorer® and Edge® are trademarks of the Microsoft group of companies.  
Safari® is a trademark of Apple Inc.

P/N XAD-00E-257-01G